

**■Features**

- High Luminous PLCC2 Top SMD LEDs
- 3.5x2.8x1.9mm Standard Directivity
- Long Lifetime Operation
- Superior Weather-resistance
- Green Diffused Type

**■Applications**

- Backlighting (switches, keys, displays, illuminated advertising etc.)
- Substitution of Micro Incandescent Lamps
- Reading Lamps / Emergency Lighting
- Marker lights (e.g. steps, exit ways, etc.)
- Other Lighting

**■Outline Dimension**

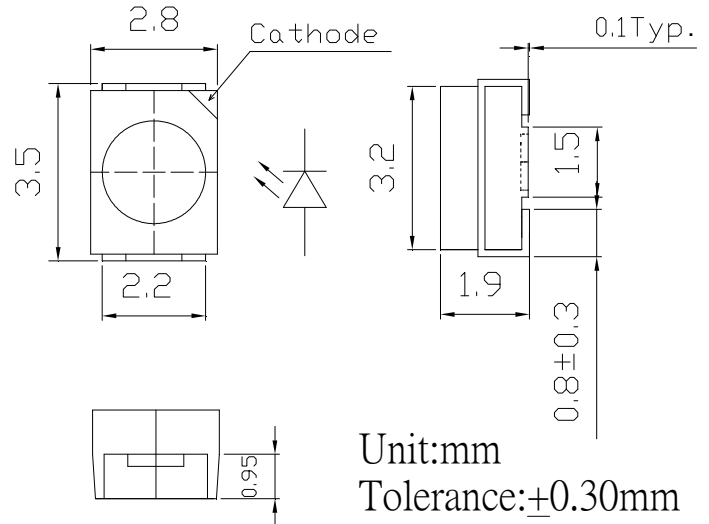

**■Absolute Maximum Rating**

(Ta=25°C)

Item	Symbol	Value	Unit
DC Forward Current	I <sub>F</sub>	30	mA
Pulse Forward Current*	I <sub>FP</sub>	100	mA
Reverse Voltage	V <sub>R</sub>	5	V
Power Dissipation	P <sub>D</sub>	108	mW
Operating Temperature	T <sub>opr</sub>	-30 ~ +85	°C
Storage Temperature	T <sub>stg</sub>	-40~ +100	°C
Lead Soldering Temperature	T <sub>sol</sub>	260°C/5sec	-

\*Pulse width Max.10ms Duty ratio max 1/10

**■Directivity**

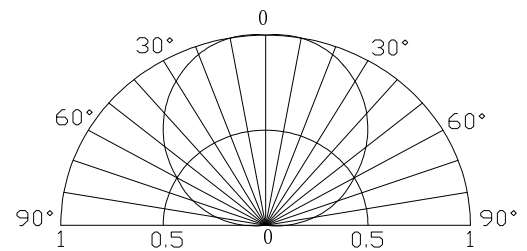

**■Electrical -Optical Characteristics**

(Ta=25°C)

Item	Symbol	Condition	Min.	Typ.	Max.	Unit
DC Forward Voltage	V <sub>F</sub>	I <sub>F</sub> =20mA	2.8	3.1	3.6	V
DC Reverse Current	I <sub>R</sub>	V <sub>R</sub> =5V	-	-	10	μA
Luminous Flux	Φ <sub>v</sub>	I <sub>F</sub> =20mA	4.0	4.5	-	lm
Chromaticity Coordinates*	x	I <sub>F</sub> =20mA	-	0.19	-	
	y	I <sub>F</sub> =20mA	-	0.15	-	
50% Power Angle	2θ <sub>1/2</sub>	I <sub>F</sub> =20mA	-	120	-	deg

\*1 Tolerance of measurements of chromaticity coordinate is ±10%

\*2 Tolerance of measurements of luminous flux is ±15%

\*3 Tolerance of measurements of forward voltage is ±0.1V